

Article number: 20958468

Description: E+G Levelling foot  
GN 343.3-50-M12-G

## Measures

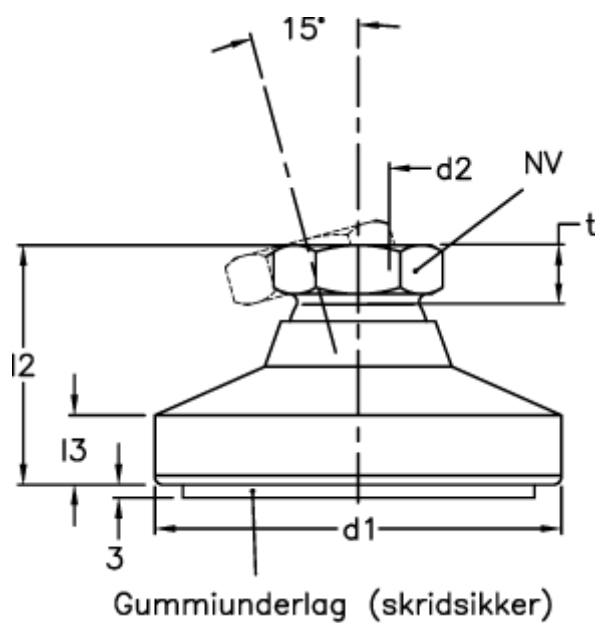

$d1$	= 50
$d2$	= M12
$l2$	= 27.5
$l3$	= 7.0
$NV$	= 17.0
Static load (N)	= 10000
$t$ min	= 11.5